



Nikon ^(th)
100
anniversary

Upright Microscope
ECLIPSE
Ni

See the evolution

The Ni series, the ultimate in upright biological microscope evolution, supports bioscience studies with enhanced basic performance and flexible system expandability.

The newly developed CFI Plan Apochromat λ (lambda) series objectives are the key to the series' optical performance. Nano Crystal Coat, with its ultra low refractive index, is employed for the first time in microscope objectives, providing brighter, high-resolution and high-contrast microscopy images.

Nikon's proprietary stratum structure, used and highly acclaimed for inverted research microscopes, is now incorporated in an upright microscope, allowing a combination of components to be installed.

Applications using laser and fluorescent proteins, such as Kaede and PA-GFP, are possible with the addition of a two-tiered fluorescent unit and a photoactivation unit.

The Ni series transcends the concept of conventional upright microscopes and expands the possibilities of advanced research in fields such as bioscience and medicine.

Ni

■ System expandability

- Nikon's proprietary stratum structure enables efficient system construction.
- The numerous accessories can be custom combined depending upon application.

■ Optical performance

- CFI Plan Apochromat λ objectives with chromatic aberration correction and high transmission throughout a broad range of wavelengths
- Objectives with improved transmission in near IR wavelength range for multiphoton excitation imaging

■ Design

- 3D ergo design combines functionality with sophistication.

■ Operability

- Ni-E: Motorized model with automatic change of observation conditions and adjustment of microscope accessories.
- Ni-U: Manual model with some motorized options.
- Most microscope controls can be operated with easy-to-reach buttons on the front of the Ni-E.



Nikon

Nikon
MADE IN JAPAN
C-TAQ

AF-ON
AF-L
AF-ON
AF-L
AF-ON
AF-L
AF-ON
AF-L

F-STOP
0
1
2
3
4
5
6
7
8
9
10
11
12

A-STOP
0
1
2
3
4
5
6
7
8
9
10
11
12

The Ni series microscopes meet all research demands

These microscopes have three features: expandability of the system due to the stratum structure that enables optical paths in two tiers; superior optical performance, as represented by the Plan Apochromat λ series objectives; and high-speed motorized accessories. The Ni series is designed to meet the needs of all advanced bioscience and medical research.



Cell biology

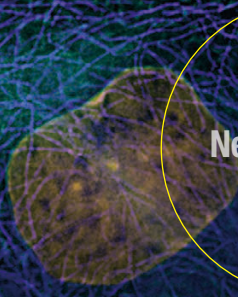

Neuroscience

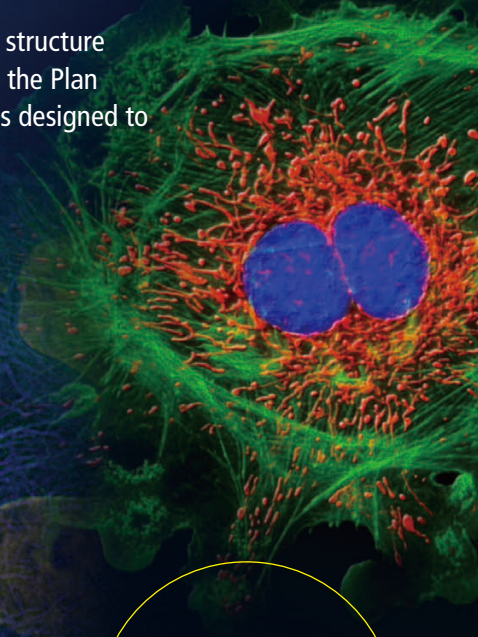

Pathology



Developmental biology

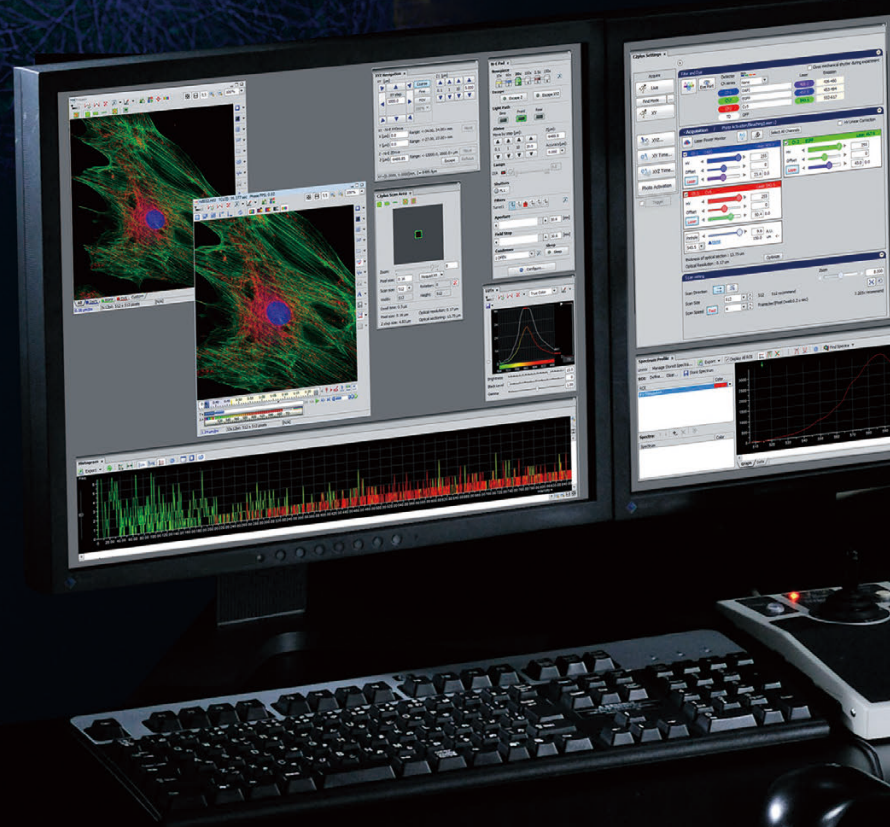

Microscopy images courtesy of:
(Left) Torsten Wittmann
(Center) Michael W. Davidson
(Right) Jennifer Waters and Adrian Salic

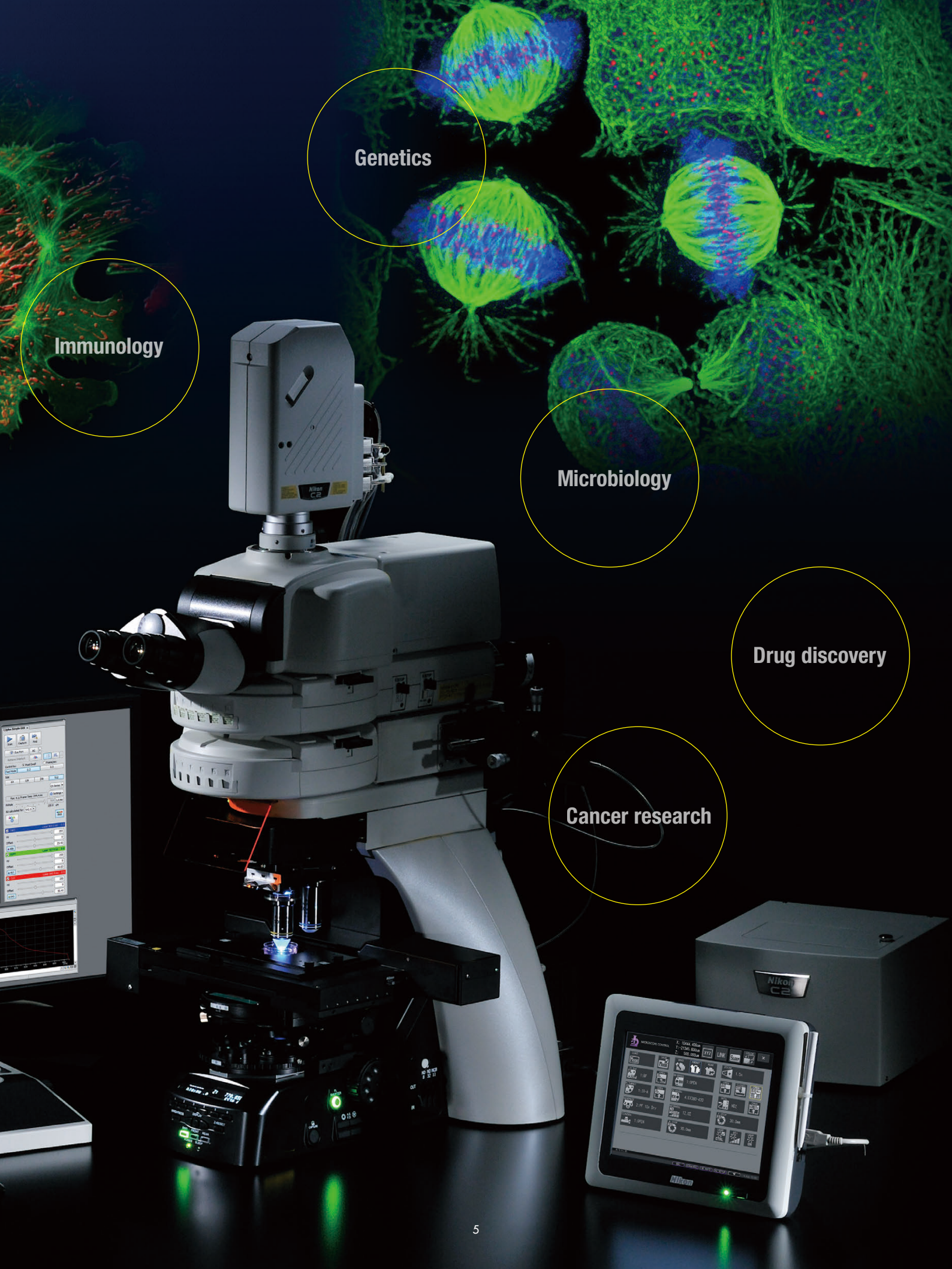

Genetics

Immunology

Microbiology

Drug discovery

Cancer research

Expandable system broadens application possibilities

Multi-color fluorescent imaging (Ni-E)

Demand for multi-color fluorescent imaging that uses newly developed fluorescent proteins and fluorescent reagents is constantly increasing. Nikon meets such needs with diverse functions and optical technologies.

High-speed motorized components

The higher speeds of the motorized excitation and barrier filter wheel and the motorized shutter enable quick wavelength changes, reducing photobleaching of the specimen. It can be operated via easily accessible control buttons, increasing operation efficiency.

CFI Plan Apochromat λ series objectives

Transmission and chromatic aberration correction have been improved throughout the wide range of visible to near IR wavelengths, allowing use of various fluorescent reagents. They provide bright, high-contrast, high S/N (signal-to-noise) ratio multi-color fluorescence images with almost no focus shift when used with any wavelength.

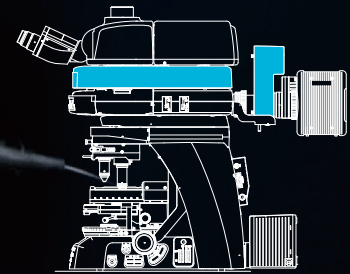

Mounted motorized excitation/barrier filter wheel

Ni-E

Multi-color
fluorescent
observation

FISH

Signal
conversion

Photoactivation imaging (Ni-E/Ni-U)

Research into the reactions and changes of stimulated cells has become popular in recent years. Nikon has developed a new photoactivation unit for upright microscopes, a first in microscopy.

Flexible stratum structure

This structure allows two-layer mounting of a photoactivation unit with an epi-fluorescence attachment.

Objectives for long-wavelength laser

With CFI Plan Apochromat λ objectives, chromatic aberration has been corrected up to 850 nm and transmission improved in the long wavelength range, increasing accuracy and efficiency of laser excitation at target site.

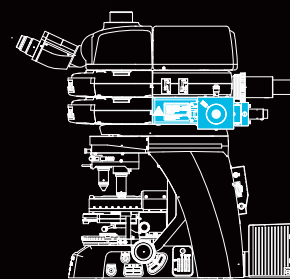

Mounted photoactivation unit

Ni-E

Ni-U

Photo-
activation

FRAP



Simultaneous multichannel imaging (Ni-E/Ni-U)

The Ni's back port and the quadocular tilting tube allow the user to acquire simultaneous, two-channel images on separate cameras. This feature is invaluable for applications such as FRET.

■ Simultaneous imaging with two cameras

The Ni's flexible stratum structure enables incorporation of a back camera port unit, allowing simultaneous image acquisition of two different wavelengths with two different cameras mounted on the back port unit and the quadocular tilting tube. This enables the capture of high-resolution images in the entire frame for each wavelength without dividing the CCD chip. The use of individual cameras for acquisition allows the user to tailor acquisition parameters for each channel independently, allowing acquisition of high-sensitivity FRET images.

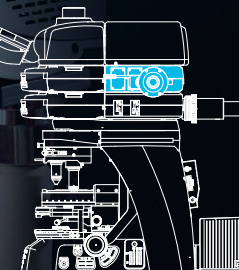

Mounted back port unit

Ni-E

Ni-U

FRET

Ratio
imaging

Multiphoton imaging (Ni-E)

Multiphoton microscopy in which long excitation wavelengths are used to allow less-invasive imaging of ever deeper areas of cells is gaining popularity. The design of the Ni-E model is optimized for multiphoton imaging in both optical and mechanical systems to meet the demands of today.



Objective dedicated to multiphoton imaging

CFI75 Apochromat 25xW MP objective features chromatic aberration correction over a broad wavelength range from 405 to 950 nm, high NA (numerical aperture) (1.10) and longer working distance (2.0 mm), and compatibility with water immersion and water dipping.

High-sensitivity multiphoton detector (NDD)

Newly developed episcopic NDD (non-descanned detector) unit incorporates a detector that efficiently senses weak signals from deep areas of live specimens. In combination with a diasopic NDD unit, transmitted signals can be also detected.

Retrofittable focusing nosepiece mechanism

Microscopes can be modified by switching the focusing stage and focusing nosepiece, enabling fixed-stage configuration to meet demands of experiments such as *in vivo* imaging.

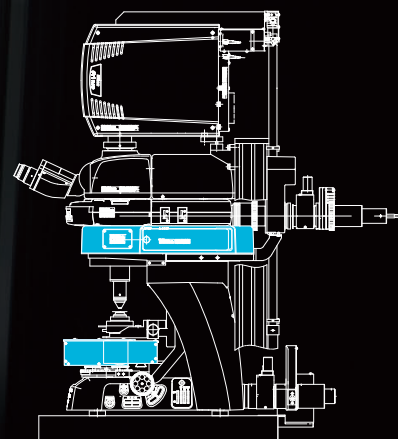

Mounted episcopic NDD unit and diasopic NDD unit

Ni-E

**In vivo
imaging**

**Two-photon
imaging**

**Photo
activation**



Versatile microscopes meet all demands

Manual and motorized models

To meet diverse user demands for operability, system expandability and motorized control, Nikon provides two Ni series models. The Ni-U, which has compatibility with some motorized accessories, is the manual model suitable for high-quality image observation and digital imaging. The Ni-E is a fully motorized model that is efficient for experiments requiring comprehensive control of various devices, such as photoactivation units and confocal systems.

Ni-U (manual model)

- Ergonomic tube and stage handle height adjustment mechanism allow comfortable viewing positions.
- Stratum structure and sturdy design improve expandability.
- Motorized nosepiece, motorized epi-fluorescence cube turret, motorized shutter can be utilized.



Ni-U configured with an ergonomic binocular tube



Ni-E configured with a motorized epi-fluorescence cube turret and motorized universal condenser

Ni-E (motorized model)

- High-precision motorized focusing
- Broad range of motorized accessories that can be used in combination.
- Observation conditions can be changed at a simple push of a button.
- Stratum structure and sturdy design improve expandability.
- 3D ergo design buttons with improved operability are located close together for speedy operations.
- Microscope settings in use can be verified on the display.
- Optimized for multiphoton excitation imaging
- Two focusing mechanism options: focusing stage and focusing nosepiece

Ni-E provides fully motorized operations

Automatic adjustment with objective changeover

Condenser, aperture and field diaphragm, and ND filter are automatically set to the optimal position during objective changeover. In addition, stage XYZ travel amount per handle rotation and parfocal distance deviation correction are automatically adjusted. Microscope settings can also be manually adjusted.

Change of observation conditions

Selected observation conditions can be designated to individual buttons, enabling changes to be made at the push of a button. This is particularly convenient when reproducing specific observation conditions.



High-precision motorized focusing

High-precision Z-focus incorporated by the Ni-E provides accurate Z-position information required for use with confocal laser microscopes. Individual coarse and fine focus knobs provide enhanced ease of operation.



Technologies supporting the Ni series

Supreme optical performance

As a light microscope manufacturer, Nikon has cultivated high technical capabilities and confidence. With its advanced technologies extending from optical glass production to lens design, fabrication, coating and processing, Nikon provides unsurpassed optical performance.

High-performance objective lens

● CFI Plan Apochromat λ series

With remarkably high NA, greatly improved transmission in the long wavelength range thanks to Nikon proprietary Nano Crystal Coat, and chromatic aberration correction over 435 to 850 nm, these objectives are ideally suited not only for brightfield and DIC observations but also for fluorescent observations. These lenses allow acquisition of bright and clear images at any wavelength for near-IR imaging and multi-color fluorescence imaging. Because bright images can be captured even with a weak excitation light, damage to a specimen is minimized.



Nano Crystal Coat

This anti-reflective coating that consists of nanometer-size particles is based on semiconductor manufacturing technology and is also used for Nikon camera lenses. The coarse structure with particles arranged in a spongy construction with uniform spaces between them enables extremely low refractive indices.

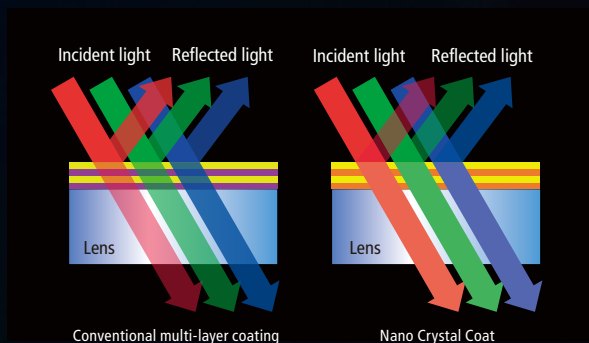
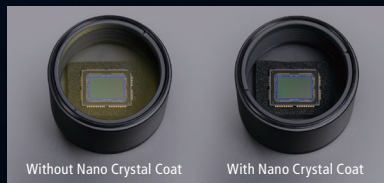

● Water dipping objective lenses

With a long working distance and high NA, these objectives provide excellent transmission in near IR wavelength range. The axial chromatic aberration of 40x and 60x objectives has been corrected to up to 850 nm, allowing high-resolution images of minute structures in thick specimens during IR-DIC observation. The 25xW MP and 100x objectives feature high NA (1.1) and a long working distance (2.0 mm). With chromatic aberration corrected in the IR region, these objectives are ideal for multiphoton excitation observation. In addition, by employing a mechanism to compensate for the changes in spherical aberration that occur at different temperatures and depths of observation points, clear images of areas deep within a thick specimen can be captured.





Uniformly bright illumination

The "fly-eye" lens is ideally suited to diascope illumination optical systems. Uniform and bright illumination up to the viewfield periphery is provided at any magnification.

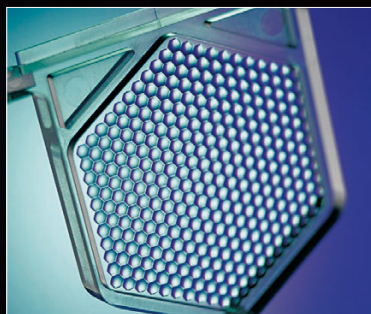

Fluorescence noise elimination

Nikon's proprietary noise terminator mechanism is employed in the epi-fluorescence cube turret and filter cubes. The S/N ratio has been dramatically improved by thoroughly eliminating stray light in the filter cubes, allowing images of weak fluorescent signals to be captured with high contrast and brightness.

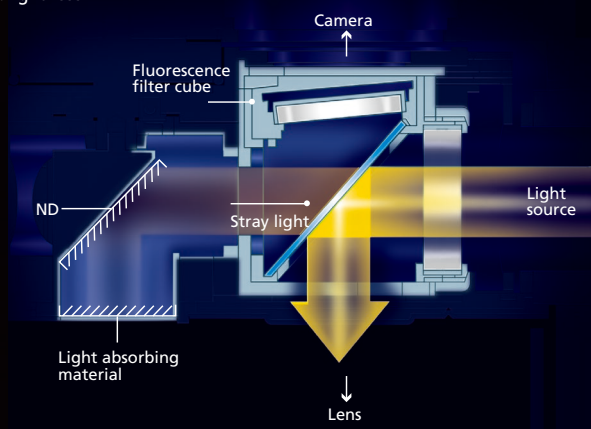

Excellent image acquisition with all observation methods

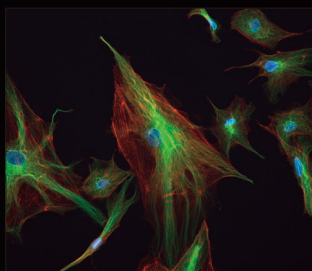

Epi-fluorescence observation

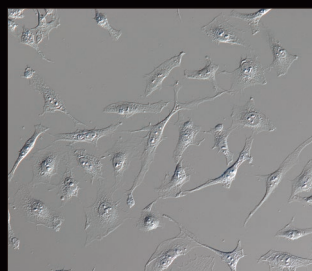
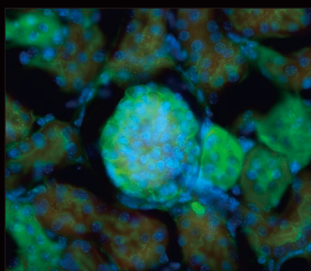

DIC (Differential Interference Contrast) observation

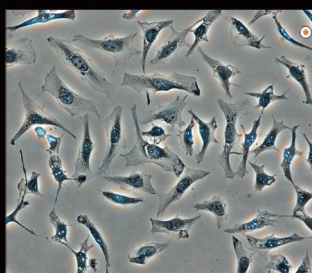
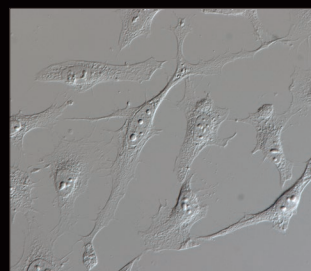

Phase contrast observation

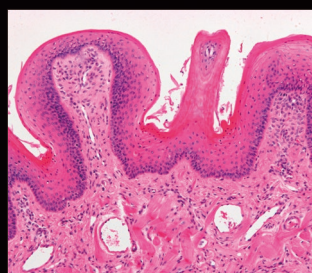
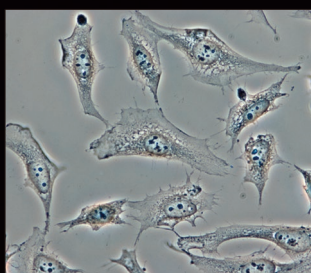

Brightfield observation

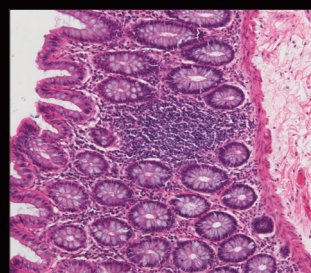

Ultimate ease, speed and clarity in imaging

Digital imaging

The Ni series can be controlled in conjunction with a Digital Sight series digital camera, facilitating effortless digital imaging. Images can be captured with a dedicated button on the microscope body. Camera control from the software GUI on a PC and the touch panel on the camera control unit* is also possible. * For C-mount cameras

● Image capture button

Images can be acquired by simply pressing the image capture button located on the microscope base.



● Stand-alone control unit DS-L3 for C-mount cameras

Stand-alone control unit DS-L3 allows the Digital Sight series C-mount digital camera to be set up and operated without a PC connection. It also enables image acquisition from a PC through a network. The DS-L3 is firmware based, and therefore will not compromise your facility's network.

- Optimal imaging parameters for each observation method can be selected using icons and simple measurements can be taken.
- Camera, motorized microscope functions and peripheral devices can be comprehensively controlled.
- Microscope status data, such as objective lens, fluorescent filter cube and condenser information, is automatically saved along with the captured image when a motorized or intelligent unit is attached.
- Operations can be controlled with a mouse or a touch panel operated by touch or stylus pen.
- Required icons can be selected and laid out as desired.

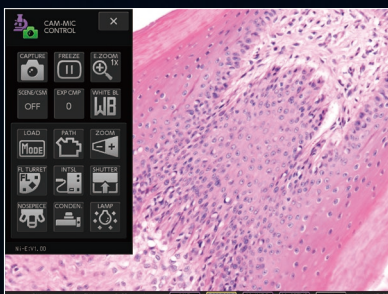

Camera/microscope control

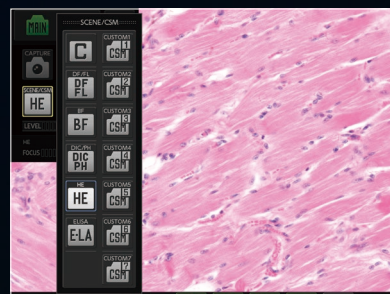

Scene mode icons



Microscope control

- Combination of Ni-E and motorized stage enables large-image acquisition.



L3 ASSIGN MODE
GUI for scan area setting



Digital cameras for microscopes

A wide range of digital cameras for microscopes from the Digital Sight series are available, including compact C-mount camera heads and fast, high-definition, F-mount cameras equipped with the Nikon FX-format CMOS sensor, which eliminates the need for a camera control unit.

F-mount CMOS cameras

- **Microscope Camera DS-Ri2**

This 16.25-megapixel, high-definition camera is equipped with a Nikon FX-format CMOS sensor. The high frame rate of up to 45 fps (1636 x 1088 pixels) enables fast focusing. The new image processing engine allows accurate color reproduction of microscopy images. Color fluorescent images can be clearly captured with its low-noise design.



- **Monochrome Microscope Camera DS-Qi2**

Equipped with monochrome CMOS sensor (16.25-megapixel). High-speed image capture of up to 45 fps (1636 x 1088 pixels). High sensitivity and superb S/N ratio design. Moreover, mounting a Peltier cooling device provides bright fluorescent images. Reliable quantitative analysis with excellent linearity.



C-mount CCD camera heads

- **High-definition cooled color camera head DS-Fi1c**

Equipped with a 5-megapixel CCD. The cooling mechanism reduces heat-induced noise, making it ideal for fluorescent image acquisition.



- **High-definition color camera head DS-Fi2**

Equipped with a 5-megapixel CCD. Displays live images at max. 21 fps. Minute structures can be captured in brightfield, phase contrast and DIC observations.



Imaging Software NIS-Elements

NIS-Elements seamlessly integrates cameras, peripheral devices, and the Ni, serving as a powerful yet easy-to-use interface for complex imaging experiments. Powerful tools for quick processing, measurement and acquired data management provide a one-step solution for acquisition and analysis.

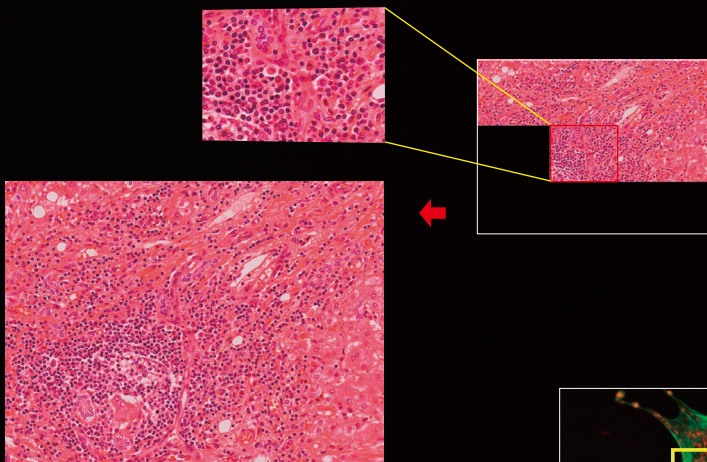
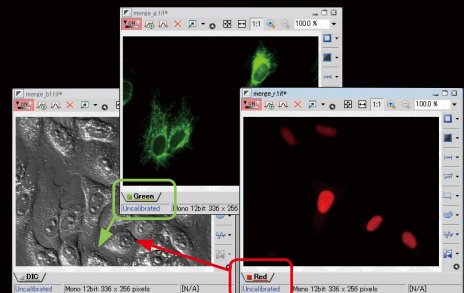
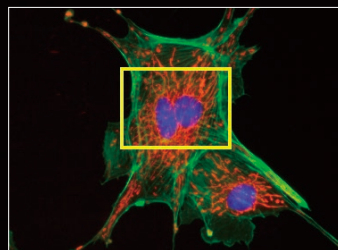

Image stitching (large image)



Merge channels



Histogram

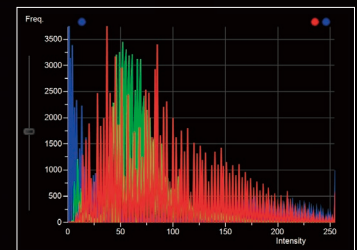

High-resolution confocal imaging systems

Combining the Ni-E's high-precision Z-focus mechanism with a confocal scanner allows high-resolution, high-S/N-ratio imaging of 3D structures of organs and cells. The Ni-E can be configured with either a focusing stage or a focusing nosepiece, catering to specific imaging requirements. Nikon offers a wide range of confocal systems that can accommodate various needs.

- **Multiphoton confocal microscope A1 MP⁺/A1R MP⁺**

A1 MP⁺ enables high-resolution multiphoton imaging (up to 4096 x 4096 pixels). In addition, A1R MP⁺ is capable of high-speed multiphoton imaging of up to 420 fps. The high-performance detectors enable deep imaging of living specimens with high sensitivity. The NDD also enables high-speed, accurate unmixing of GFP and YFP.

- **Confocal microscope C2⁺**

C2⁺ features a compact design and high functionality. The C2⁺ allows users to acquire simultaneous 3-channel and diascopic DIC images and provides powerful imaging modalities, such as large-image stitching.

- **Confocal microscope A1⁺/A1R⁺**

A1⁺ incorporates a high-definition (up to 4096 x 4096 pixels) non-resonant scanner. A1R⁺ also incorporates a high-speed (up to 420 fps) resonant scanner, in addition to the non-resonant scanner, enabling true simultaneous photoactivation and imaging.

- **Spectral imaging confocal microscope A1si⁺/A1Rsi⁺/ C2si⁺**

By incorporating a spectral detector, a wide wavelength spectrum of 320 nm can be acquired with a single scan. Closely overlapping spectra can be unmixed cleanly with minimal crosstalk.

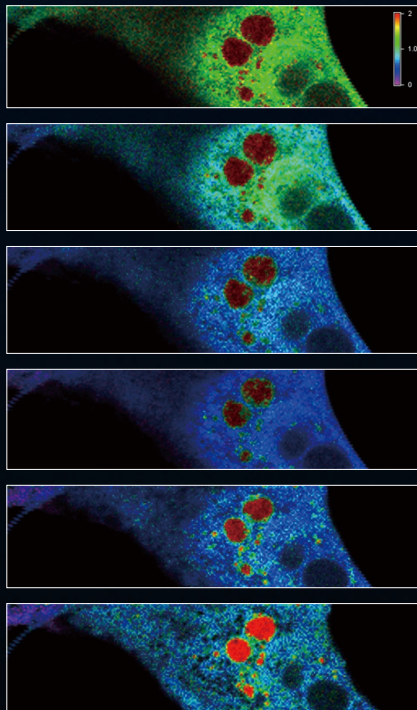

RK13 rabbit kidney epithelial cell stably transfected with the calcium biosensor Yellow Cameleon 3.6. The cell was exposed to ionomycin to raise intracellular calcium and induce FRET. The color change indicates changes in the level of FRET. Time-lapse images were taken with the A1R (resonant scanner). Sample courtesy of: Dr. Mike Davidson, National High Magnetic Field Laboratory, Florida State University

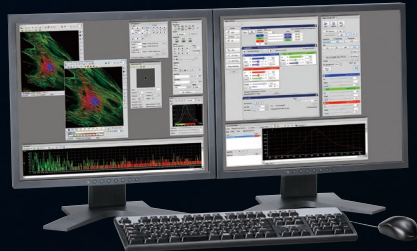

Ni-E configured with C2⁺

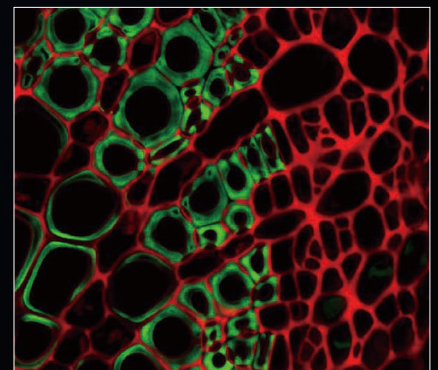
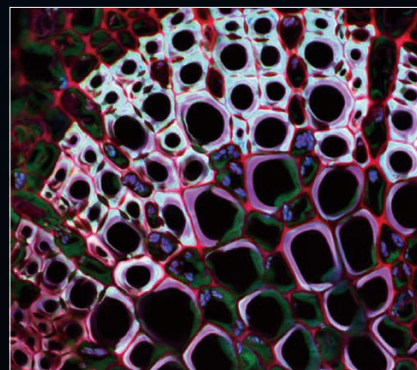

Privet leaf section (fluorescence from Fast Green, Safranin, Crystal Violet, and Orange G) (captured with A1)

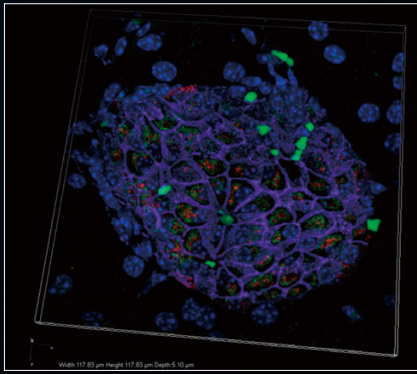

Adult mouse islet stained with anti-proinsulin, anti-beta catenin and anti-KDEL (ER marker).
Photos courtesy of: Drs. Diva Jonatan, Matt Kofron and James Wells, Cincinnati Children's Hospital Medical Center

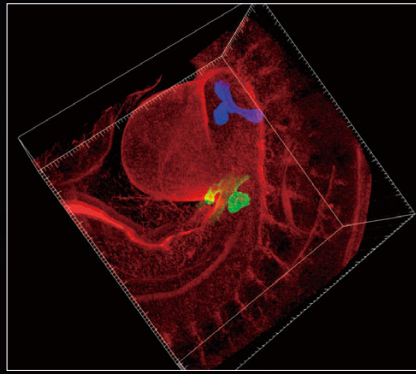

E10.5 mouse embryo wholemount stained with anti-Pdx1 (green), anti-Nkx2.1 antibodies (blue) and anti-E-cadherin to reveal the developing pancreatic and lung primordia.
Photos courtesy of: Drs. Diva Jonatan, Matt Kofron and James Wells, Cincinnati Children's Hospital Medical Center

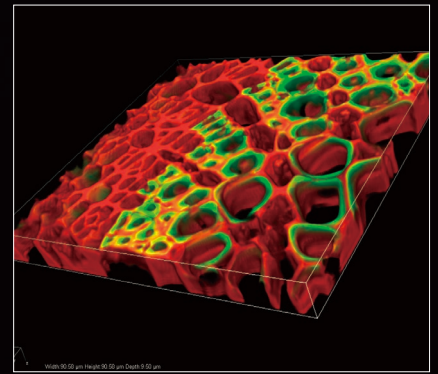

Privet leaf section (fluorescence from Fast Green, Safranin, Crystal Violet, and Orange G) (captured with A1)

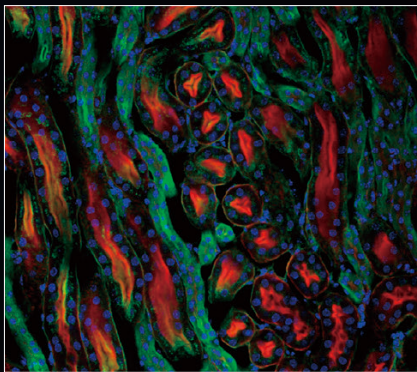

Cryosection of a mouse kidney labeled with phalloidin (actin; red), wheat germ agglutinin (green), and DAPI (DNA; blue) (captured with A1)

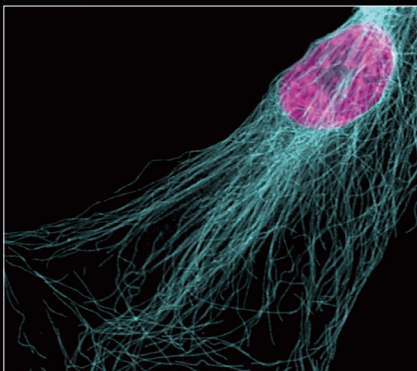

Mouse fibroblast labeled with tubulin antibodies (blue) and DAPI (DNA; magenta) (captured with A1)

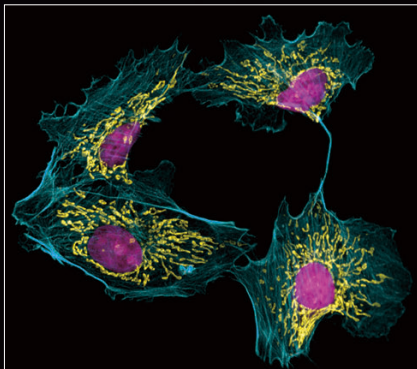

Bovine brain microvascular endothelial cells labeled with MitoTracker (mitochondria, yellow), phalloidin (actin, blue) and Hoechst (DNA, magenta). (captured with A1)



Two types of laser unit are available



The compact model consisting of LU-N4, LU-N4S and LU-N3 comes pre-installed with either four (for LU-N4/4S) or three (LU-N3) lasers. The LU-N4/N4S/N3 model achieves maximal light throughput based on its alignment-free, high-efficiency laser combiner while maintaining a compact design. The flexible model, LU-NV, which also utilizes the high-efficiency laser combining system, supports up to eight different lasers and seven output fibers, an ideal laser system for multi-modal imaging.

LU-N4/N4S 4-laser unit, LU-N3 3-laser unit

The LU-N4/LU-N4S/LU-N3 model provides one output fiber. With its compact design, this laser unit provides a space-saving solution for laser application systems.

- The LU-N4/LU-N4S is equipped with four lasers (405 nm, 488 nm, 561 nm, and 640 nm), while LU-N3 offers three lasers (405 nm, 488 nm, and 561 nm).
- The optical axis of each laser is aligned prior to shipment resulting in an effortless setup.
- The unique monolithic laser combining system prevents alignment shifts even after long-term use, resulting in consistent and maximal laser output.
- A built-in AOTF allows fast and efficient selection of wavelengths and power modulation.



Dimensions and weight

360 (W) x 210 (H) x 593.5 (D) mm, Approx. 16 kg

Installed laser wavelength and laser type

Wavelength	Laser type	Output power at the fiber end
405 nm	LD	15 mW
488 nm	LD*	15 mW*
561 nm	DPSS	15 mW
640 nm (for LU-N4/N4S)	LD	15 mW

* LU-N4S is equipped with DPSS laser (output power: 8 mW) for 488 nm wavelength.



LU-NV

The LU-NV laser combiner can be configured with up to eight different lasers and seven output fibers, providing maximal flexibility. With its multiple output fibers and fiber switching system, the LU-NV supports multiple laser applications such as photoactivation and confocal imaging on a single microscope platform.

- Available lasers for the LU-NV: 405 nm, 445 nm, 458 nm, 488 nm, 514 nm, 532 nm, 561 nm, 594 nm, 640 nm and 647 nm.
- High-power lasers for confocal microscopes are available.
- Lasers can be individually turned ON/OFF, boosting the efficiency of the lasers.
- The optical axis of each laser is aligned prior to shipment resulting in an effortless setup.
- The unique monolithic laser combining system prevents alignment shifts even after long-term use, resulting in consistent and maximal laser output.
- A built-in AOTF allows fast and efficient selection of wavelengths and power modulation.

Dimensions and weight

LU-NV laser unit: 400 (W) x 781 (H) x 685 (D) mm, approx. 70 kg

LU-controller box B: 400 (W) x 123 (H) x 687 (D) mm, approx. 7 kg



LU-NV Laser Unit with
LU Controller Box B (top)

Mountable laser wavelength and laser type

Wavelength	Laser type	Output power at the fiber end
405 nm	LD	20 mW
445 nm	LD	20 mW
458 nm	DPSS	18 mW
488 nm	DPSS	20 mW, 45 mW, 70 mW
514 nm	DPSS	20 mW, 40 mW
532 nm	DPSS	40 mW
561 nm	DPSS	20 mW, 45 mW, 70 mW
594 nm	DPSS	20 mW
640 nm	LD	20 mW, 40 mW
647 nm	Fiber	125 mW



LED and mercury light sources for epi-fluorescence microscopy

Epi-FI LED illuminator

The LED illuminator ensures stable and quantitative brightness of illumination and operational simplicity. It is particularly suited to long periods of fluorescence time-lapse imaging.



- 1 Epi-FI LED Illuminator main unit
- 2 Simple remote control pad
- 3 LED unit
- 4 Dichroic mirror unit
- 5 Epi-FI Filter Cube
- 6 HG100W Adapter R
- 7 Fiber (1.5 m/3.0 m)

C-LEDFI Epi-FI LED Illuminator



Stable light intensity

Stable illumination brightness ensures quantitative and reliable fluorescence intensity measurement.

The LED illuminator ensures minimal output fluctuation of less than 0.1% in 100 Hz (10 ms.). In addition, it maintains output fluctuation at below 3% even when the illuminator is switched on and off intermittently over 72 hours of time-lapse observation.

Zero warm-up time

The illuminator requires zero warm-up time and enables observation immediately after it is switched on. Thus it can even be employed only when capturing images during time-lapse imaging, thereby eliminating the need for fluorescence shutters.

Wavelength intensity control

The illuminator allows for a flexible combination of LED units, enabling simultaneous lighting with multiple wavelengths for multi-color observation. The intensity of the excitation LED light for each wavelength can be consecutively controlled, thereby eliminating the need for ND filters.

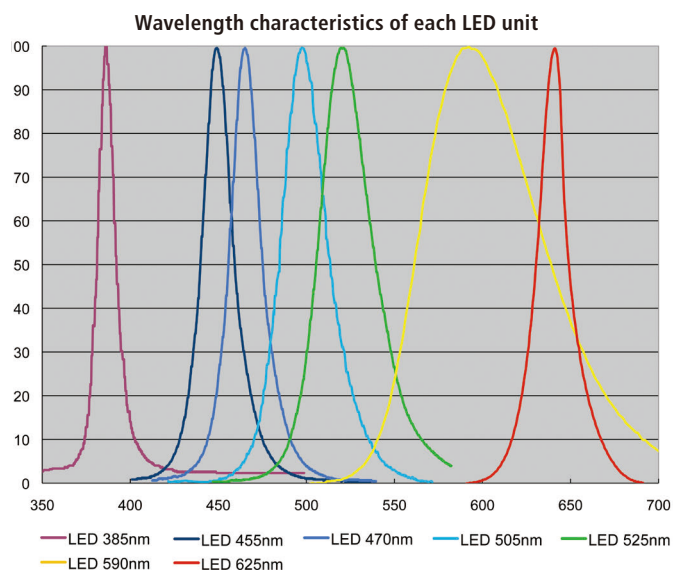

Control with NIS-Elements software

Turning the illuminator on and off and changing wavelengths in synchronization with image acquisition is possible with NIS-Elements imaging software.

Maintenance free

An LED has a minimum lifespan of 10,000 hours, eliminating the need for frequent lamp replacement.

Alignment free

The LED and dichroic units do not need to be aligned each time they are changed over. Furthermore, the Epi-FI LED Illuminator is connected to the microscope fluorescent attachment using a dedicated optical fiber cable, eliminating the need to center the light source.

Specifications

LED unit	7 types; up to 4 units can be assembled 385/455/470/505/525/590/625 nm
Dichroic mirror unit	5 types, up to 3 units can be assembled 425/455/470/565/610 nm
Fiber	Two types (1.5 m or 3.0 m)
LED control	Simple remote control pad Selection and ON/OFF of LED unit is possible. (Simultaneous lighting of multiple LEDs and light intensity control for each LED unit is possible.) Light intensity control step: 7 steps (0, 10, 20, 40, 60, 80, 100%)
	NIS-Elements software Selection and ON/OFF of LED unit is possible. (Simultaneous lighting of multiple LEDs is possible.) Light intensity control step: Minimum 0.5% linear control Intensity control of multiple LED units while retaining intensity ratios is possible. LED excitation in synchronization with image acquisition using CCD camera (time-lapse imaging) Trigger Acquisition function available
ON/OFF switching speed	Less than 100 μ s
LED auto detection	Automatic detection and display of LED unit (using NIS-Elements)
LED lifetime	Over 10,000 hours
External dimensions	135 (W) x 227 (H) x 303 (D) mm
Weight	Approx. 5.4 kg

HG Precentered Fiber Illuminator Intensilight

The Intensilight high-intensity mercury-fiber illuminator employs a precentered, long-life lamp that requires no centering while allowing users to capture high-quality fluorescence images with uniform brightness.



C-HGFI (manual)

C-HGFI (motorized)

Precentered lamp requires no alignment

The use of a precentered lamp and dedicated optical fibers eliminates the need for cumbersome centering and focusing operations, even after the lamp is replaced. Uniform brightness is always assured.

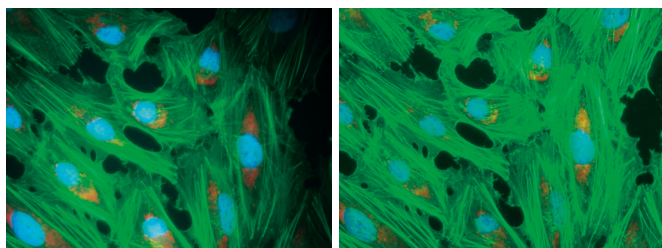

Off-center

Precentered

2000-hour long-life lamp

The lamp lasts an average of 2000 hours, or 10 times longer than conventional mercury lamps. Therefore, replacement costs and microscope downtime are greatly reduced.

Reduced heat and electrical noise

Dedicated optical fibers (1.5 m, 3 m) allow the light source to be placed away from the microscope, reducing heat and electrical noise on the microscope body. This is particularly suited to long-time fluorescence observation (time-lapse observation) of live cells.

Greatly increased brightness for green spectrum

At wavelengths of around 450 nm to 500 nm, brightness is much higher than that of a conventional mercury lamp, making the lamp ideally suited to observation of green fluorescence such as FITC and GFP.

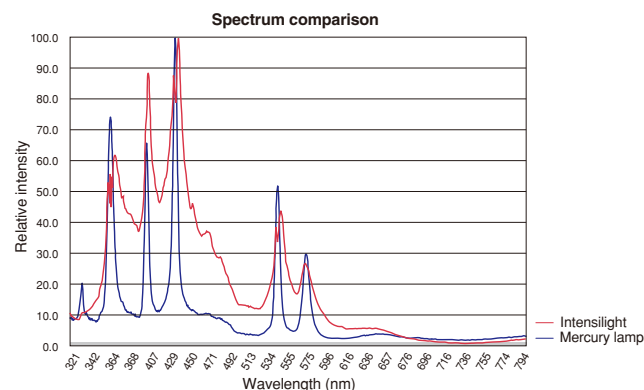

Shutter and light intensity control

There are six levels of light intensity to choose from depending on the specimen. The shutter allows light to the specimen to be easily shut off without the power being turned off. Therefore, photobleaching can be reduced to a minimum when observing multi-stained specimens.

Safety measures

When the lamp replacement cover is open or the optical fibers are not attached, the interlock automatically shuts the light off to protect the user from possible light exposure. Furthermore, when the lamp temperature sensor detects abnormally high temperatures, power is cut to protect the lamp.

DC lighting for constant light intensity

As DC (direct current) lighting is less influenced by frequency than AC (alternating current) lighting, DC provides constant, nonfluctuating light.

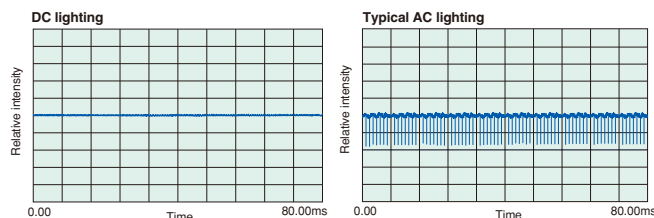

Motorized model C-HGFI available

The light intensity and shutter can be controlled from an optional dedicated remote controller or a PC that incorporates Nikon's NIS-Elements imaging software. The light intensity and shutter can be programmed for each application and controlled in conjunction with the microscope and peripheral equipment. This enables automatic control during excitation light changeover and observation of multi-stained specimens.

Specifications

Lamp	Ultrahigh pressure 130 W mercury lamp
Lamp life	Average 2000 hours
ND (light intensity)	1 (100%), 2 (50%), 4 (25%), 8 (12%), 16 (6%), 32 (3%)
Shutter response	(Motorized) 100 msec
Power supply	100-240 VAC 50/60 Hz
Dimensions (including protrusions)	(Manual) 110 (W) x 307 (D) x 278.5 (H) mm (Motorized) 110 (W) x 296 (D) x 278.5 (H) mm
Weight	Approx. 6 kg
Optical fiber length	1.5 m/3.0 m

Wide array of accessories finely segmented by function



Motorized quadocular tilting tube (Ni-E)

Motorized changeover of optical paths is possible. Eyepiece inclination can be adjusted from 15° to 35°.



Motorized DSC zooming port (Ni-E)

A digital camera can be mounted on the camera port. A motorized 0.6x - 2.0x zoom optical system is incorporated.



Motorized ND filter (Ni-E)

Brightness is automatically optimized with the changeover of the motorized nosepiece. Motorized adjustment of desired brightness is also possible.

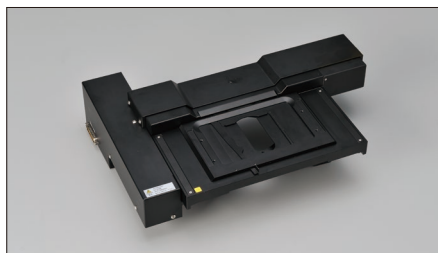

Motorized XY stage (Ni-E)

Effective for applications that require highly accurate positioning, such as photoactivation imaging and FISH.



Joystick for motorized stage (Ni-E)

Makes control of motorized XY stage possible.



Ergo controller (Ni-E)

In addition to motorized microscope operation, XYZ control of stage is possible with similar operational ease as that of an actual microscope.



Motorized universal condenser Dry (Ni-E)

High-speed motorized changeover of condenser modules for brightfield, phase contrast, DIC and simple darkfield observations is possible.



Motorized barrier filter wheel (Ni-E)

Barrier filter positions (7 positions—using 25 mm filters) can be changed at a high speed of 0.2 sec. between adjacent positions.



Motorized excitation filter wheel (Ni-E)

Excitation filter positions (8 positions—using 25mm filters) can be changed at a high speed of 0.15 sec. between adjacent positions.

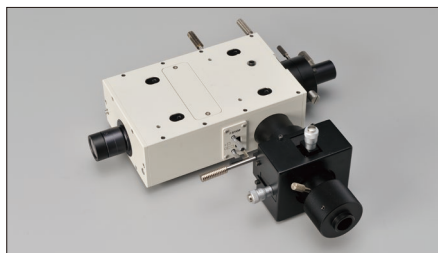

Photoactivation unit (Ni-E, Ni-U)

Laser light photoactivation and episcopic illumination are possible. Both the photoactivation unit and the confocal system can be used with a single laser source.



Back port unit (Ni-E, Ni-U)

Enables simultaneous acquisition of images with two different wavelengths using two cameras. Dedicated cubes are optional.



Motorized DIC sextuple nosepiece (Ni-E, Ni-U)

Objective magnification is automatically saved along with the captured image. Built-in prism/analyzer plate slot.



Motorized epi-fluorescence cube turret (Ni-E, Ni-U)

Noise terminator provides high S/N ratio. Six filter cubes can be installed. Either an epi-fluorescence attachment or a photoactivation unit can be attached.



Motorized shutter (Ni-E, Ni-U)

High-speed shutter control is possible. The shutter can be attached to diascopic and episcopic illumination systems.



Simple remote control pad (Ni-U)

Motorized operation of nosepiece, epi-fluorescence cube turret and shutter is possible.

Dimensional diagram

Ni-E (for use with focusing nosepiece)

Configured with an Ni photoactivation unit, two-tiered motorized epi-fluorescence cube turret and motorized quadrocular tilting tube

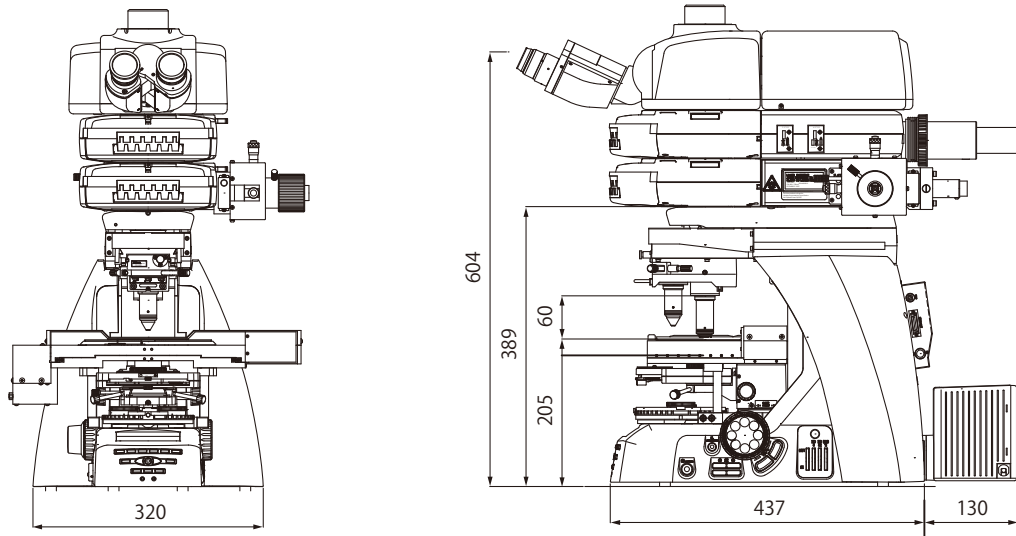

Ni-U

Configured with an epi-fluorescence cube turret and quadrocular tilting tube

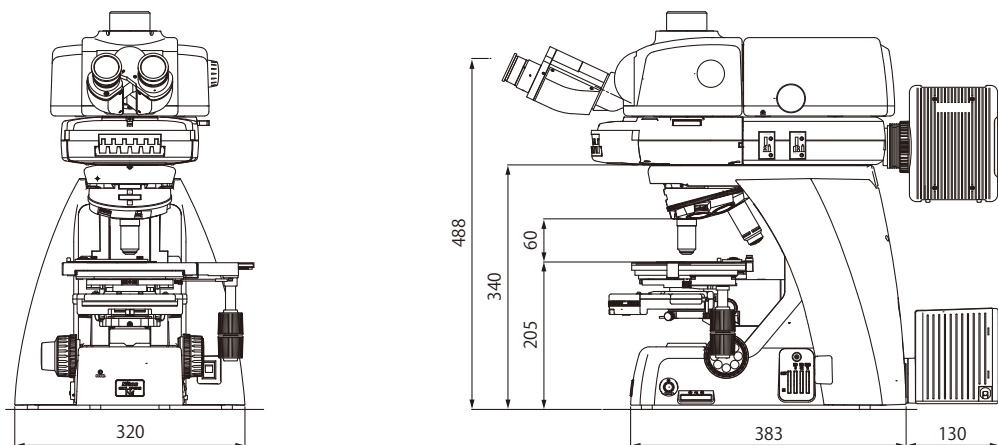

Ni-U

Configured with an ergonomic binocular tube and DSC port

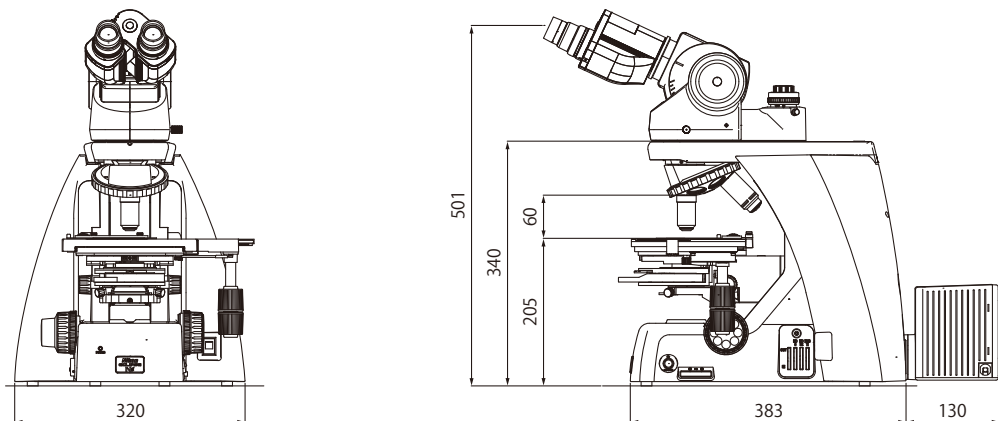

Unit: mm

System diagram: Ni-E focusing stage type

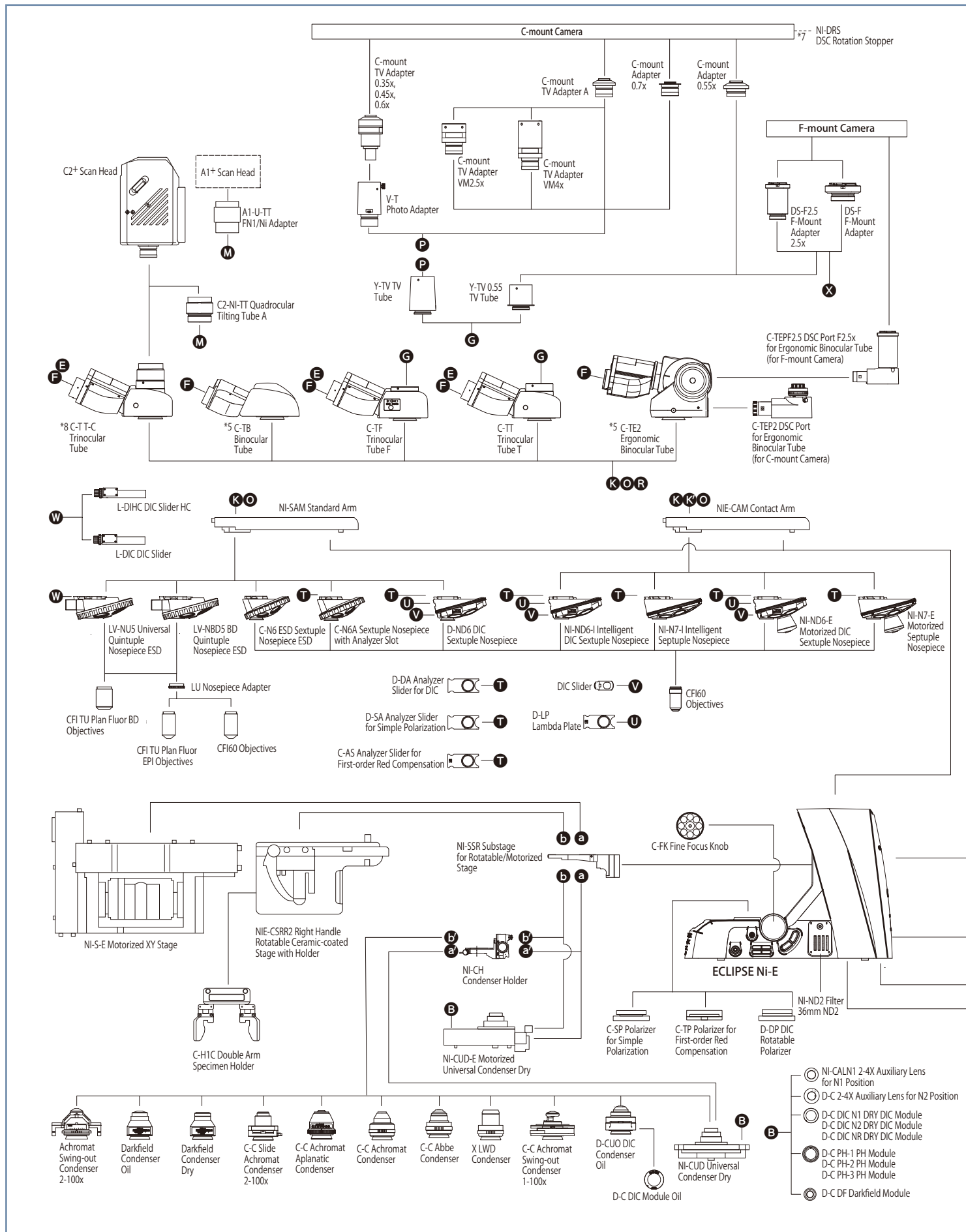

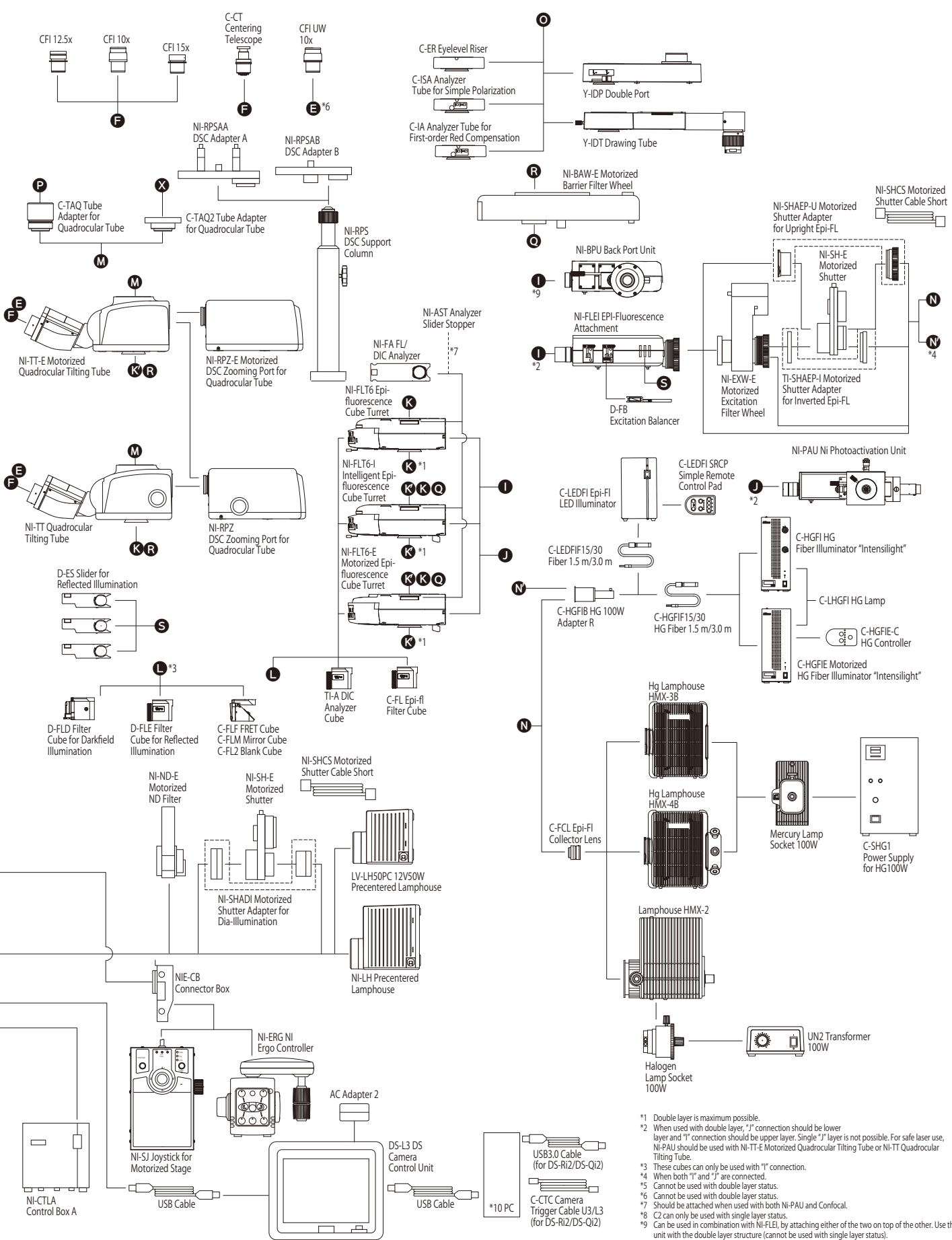

- *1 Double layer is maximum possible.
- *2 When used with double layer, "J" connection should be lower layer and "I" connection should be upper layer. Single "J" layer is not possible. For safe laser use, NI-PAU should be used with NI-TT-E Motorized Quadrocular Tilting Tube or NI-TT Quadrocular Tilting Tube.
- *3 These cubes can only be used with "I" connection.
- *4 When both "I" and "J" are connected.
- *5 Cannot be used with double layer status.
- *6 Cannot be used with double layer status.
- *7 Should be attached when used with both NI-PAU and Confocal.
- *8 C2 can only be used with single layer status.
- *9 Can be used in combination with NI-FLEI, by attaching either of the two on top of the other. Use the unit with the double layer structure (cannot be used with single layer status).
- *10 A computer is required for using a DS-Ri2 or DS-Qi2 camera or NIS-Elements software.

System diagram: Ni-E focusing nosepiece type

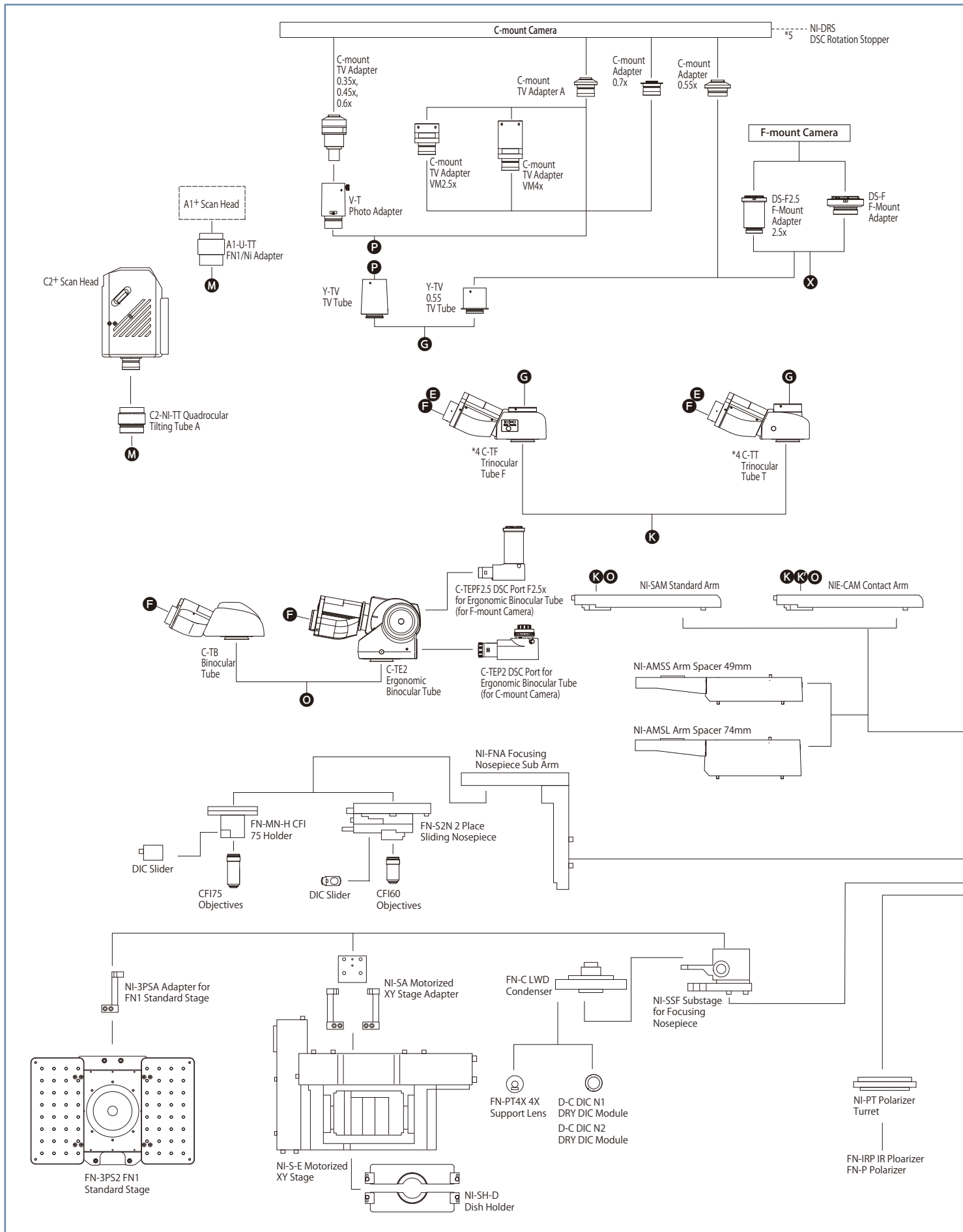

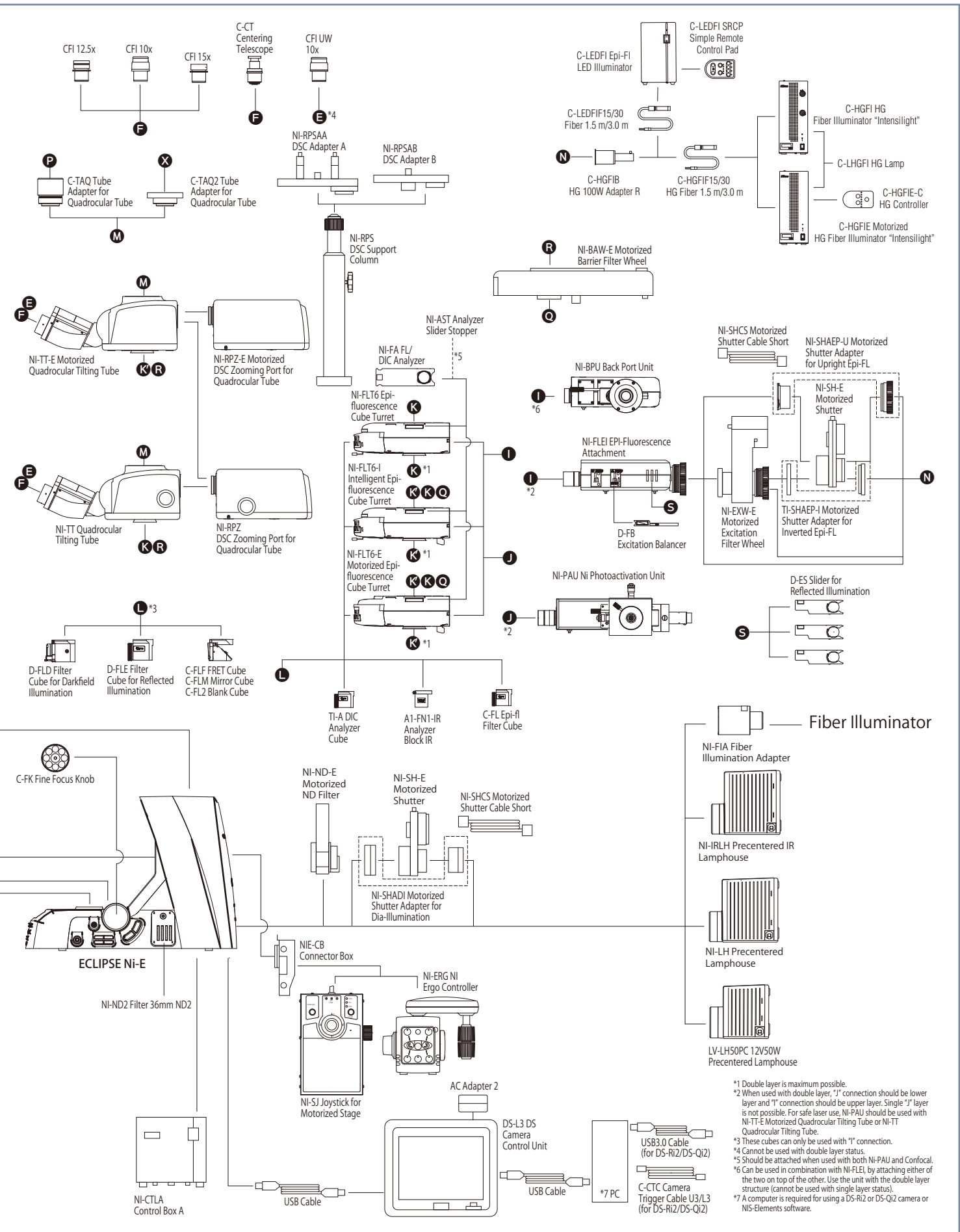

*1 Double layer is maximum possible.
 *2 When used with double layer, "J" connection should be lower layer and "I" connection should be upper layer. Single "J" layer is not possible. For safe laser use, NI-PAU should be used with NI-TT-E Motorized Quadrocular Tilting Tube or NI-TT Quadrocular Tilting Tube.
 *3 These cubes can only be used with both NI-PAU and Confocal.
 *4 Cannot be used with double layer status.
 *5 Should be attached when used with both NI-PAU and Confocal.
 *6 Can be used in combination with NI-FLEI, by attaching either the two on top of the other. Use the unit with the double layer structure (cannot be used with single layer status).
 *7 A computer is required for using a DS-Ri2 or DS-Qi2 camera or NIS-Elements software.

System diagram: Ni-U

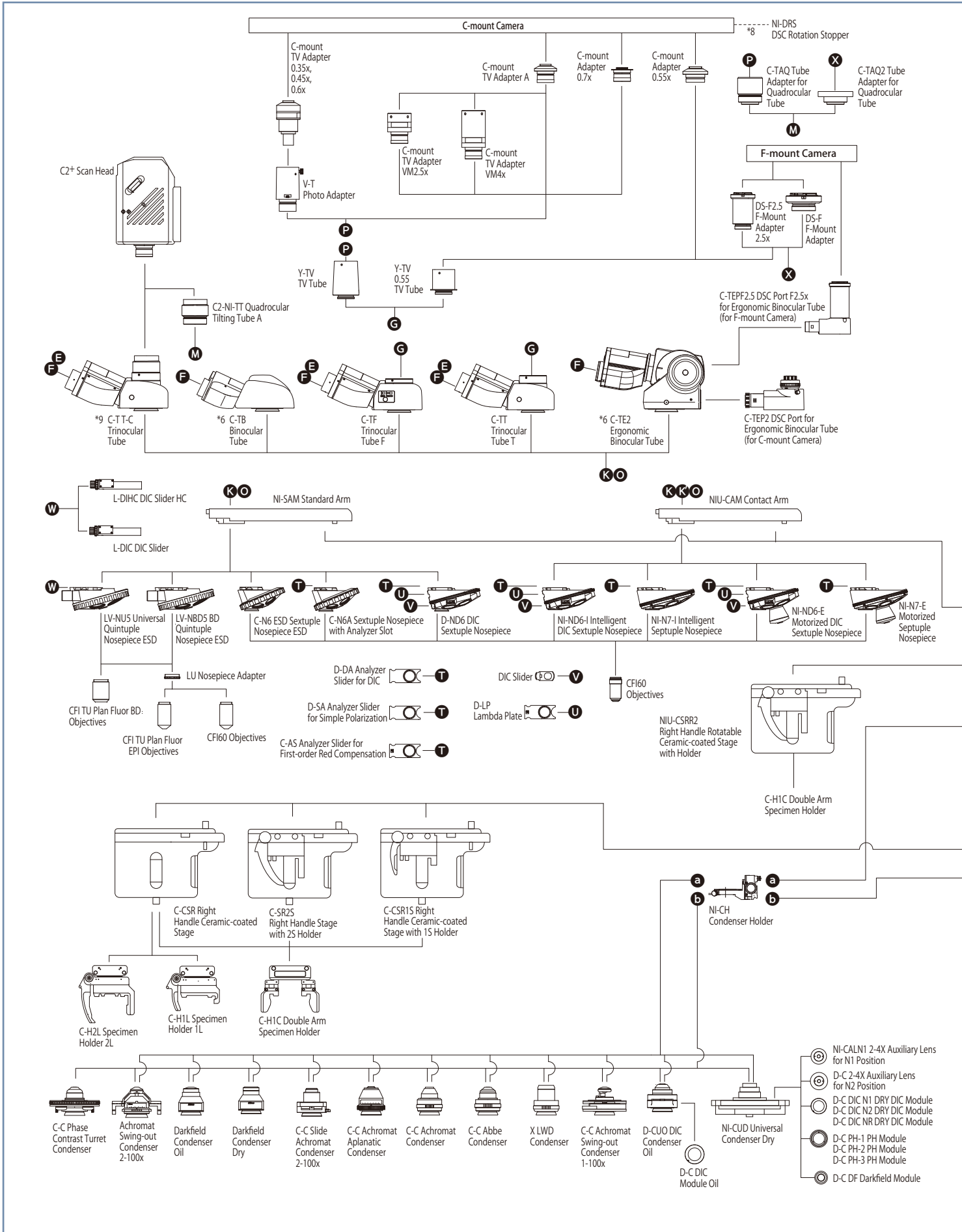

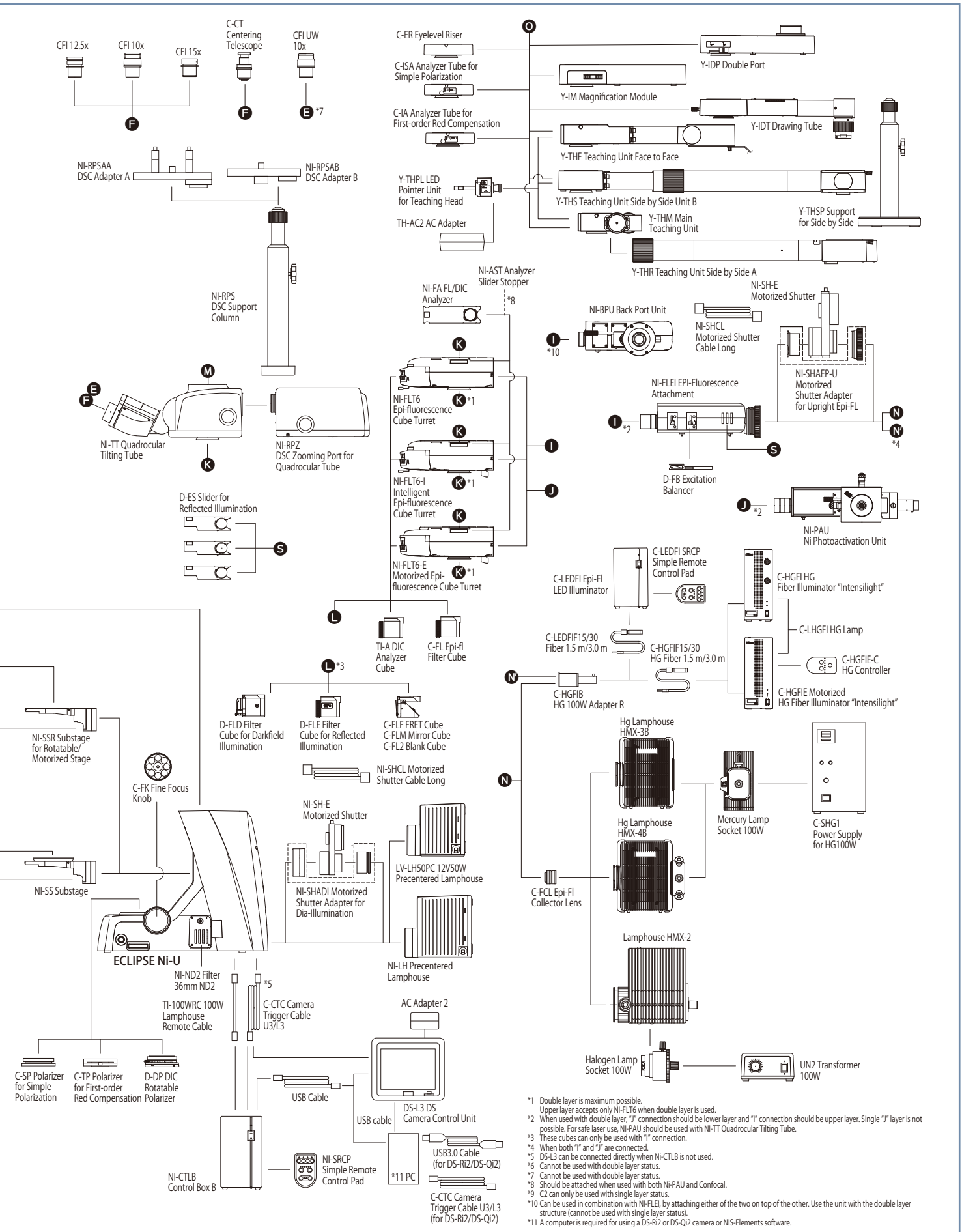

*1 Double layer is maximum possible.
 Upper layer accepts only NI-FLT6 when double layer is used.
 *2 When used with double layer, "J" connection should be lower layer and "I" connection should be upper layer. Single "J" layer is not possible. For safe laser use, NI-PAU should be used with NI-TT Quadrocular Tilting Tube.
 *3 These cubes can only be used with "I" connection.
 *4 When both "I" and "J" are connected.
 *5 DS-L3 can be connected directly when Ni-CTLB is not used.
 *6 Cannot be used with double layer status.
 *7 Cannot be used with double layer status.
 *8 Should be attached when used with both NI-PAU and Confocal.
 *9 C2 can only be used with single layer status.
 *10 Can be used in combination with NI-FLE1 by attaching either of the two on top of the other. Use the unit with the double layer structure (cannot be used with single layer status).
 *11 A computer is required for using a DS-Ri2 or DS-Qi2 camera or NIS-Elements software.

Specifications

		Ni-E		Ni-U
		Focusing stage type	Focusing nosepiece type	
Main body	Optical system	CFI60 infinity optical system	CFI60 and CFI75 infinity optical systems	CFI60 infinity optical system
	Focusing (stroke from focus point)	Via motorized stage Up/Down movement (Up 2 mm/Down 13 mm)	Via motorized nosepiece Up/Down movement (Up 13 mm/Down 2 mm)	Via manual stage Up/Down movement (Up 3 mm/Down 26 mm)
		Built-in linear encoder, Resolution: 0.025 μm Motorized escape and refocus mechanism		
	Coaxial Coarse/Fine focusing			
	Illumination	Halogen lamp (12V100W) · NI-ND-E Motorized ND Filter (option)		Halogen lamp (12V100W)
		Built-in fly-eye lens Built-in NCB11, ND8, ND32 filters (detachable, one additional filter mountable) and diffuser (non-detachable) ND2 filter (option)		
Controls	Transmitted light On/Off switch, Intensity control dial with preset function Image capture button			
	Built-in motorized control switches		—	
		· Stand-alone control unit DS-L3 · NI-ERG NI Ergo Controller (option)	· Stand-alone control unit DS-L3 (option) · NI-SRCP Simple Remote Control Pad (option)	
Power supply unit	External power supply NI-CTLA Control Box A for all configurations		Built-in for halogen lamp NI-CTLB Control Box B is necessary when Motorized/Intelligent options are combined.	
Eyepieces (F.O.V. mm)		· CFI 10x (22) · CFI 12.5x (16) · CFI 15x (14.5) · CFI UW10x (25)		
Tubes	F.O.V. 22 mm (Eyepiece/Port)	· C-TB Binocular Tube · C-TE2 Ergonomic Binocular Tube (100/0, 50/50 with C-TEP2 DSC Port) Inclination angle: 10-30 degree, Extension up to 40 mm		
	F.O.V. 25 mm ^{*1} (Eyepiece/Port)	· C-TF Trinocular Tube F (100/0, 0/100) · C-TT Trinocular Tube T (100/0, 20/80, 0/100) · C-TT-C Trinocular Tube (100/0, 0/100, for confocal) ^{*2} · NI-TT Quadrocular Tilting Tube (Eyepiece/Upper port/Rear port: 100/0/0, 0/100/0, 0/0/100) Inclination angle: 15-35 degree		—
		· NI-TT-E Motorized Quadrocular Tilting Tube (Eyepiece/Upper port/Rear port: 100/0/0, 0/100/0, 0/0/100) Inclination angle: 15-35 degree		—
Ports (F.O.V. 11 mm)	· C-TEP2 DSC Port for Ergonomic Binocular Tube (with C-mount adapter, 0.7x) · C-TEPF2.5 DSC Port F2.5x for Ergonomic Binocular Tube (with F-mount adapter, 2.5x) · NI-BPU Back Port Unit (with C-mount adapter, 1.0x) · NI-RPZ DSC Zooming Port for Quadrocular Tube (with C-mount adapter, manual zoom, 0.6x - 2.0x)			—
	· NI-RPZ-E Motorized DSC Zooming Port for Quadrocular Tube (with C-mount adapter, motorized zoom, 0.6x - 2.0x)			—
Arms	· NI-SAM Standard Arm			—
	· NIE-CAM Contact Arm (for Motorized/Intelligent options)		· NIU-CAM Contact Arm (for Motorized/Intelligent options)	
Nosepieces	Motorized	· NI-N7-E Motorized Septuple Nosepiece · NI-ND6-E Motorized DIC Sextuple Nosepiece	—	· NI-N7-E Motorized Septuple Nosepiece · NI-ND6-E Motorized DIC Sextuple Nosepiece
	Intelligent	· NI-N7-I Intelligent Septuple Nosepiece · NI-ND6-I Intelligent DIC Sextuple Nosepiece	—	· NI-N7-I Intelligent Septuple Nosepiece · NI-ND6-I Intelligent DIC Sextuple Nosepiece
	Manual	· D-ND6 DIC Sextuple Nosepiece · C-N6 ESD Sextuple Nosepiece ESD · C-N6A Sextuple Nosepiece with Analyzer Slot · LV-NU5 Universal Quintuple Nosepiece ESD · LV-NBD5 BD Quintuple Nosepiece ESD	· FN-S2N 2 Place Sliding Nosepiece (for CFI60 objectives) Changeover 2 objectives, DIC slider insertable · FN-MN-H CFI 75 Holder (for CFI75 objective) DIC slider insertable	· D-ND6 DIC Sextuple Nosepiece · C-N6 ESD Sextuple Nosepiece ESD · C-N6A Sextuple Nosepiece with Analyzer Slot · LV-NU5 Universal Quintuple Nosepiece ESD · LV-NBD5 BD Quintuple Nosepiece ESD

		Ni-E		Ni-U
		Focusing stage type	Focusing nosepiece type	
Stages		<ul style="list-style-type: none"> · NIE-CSRR2 Right Handle Rotatable Ceramic-coated Stage with 2S Holder Cross travel 78(X) x 54(Y) mm Handle height and torque adjustable 	<ul style="list-style-type: none"> · FN-3PS2 FN1 Standard Stage Cross travel 30(X) x 30(Y) mm 	<ul style="list-style-type: none"> · C-SR2S Right Handle Stage with 2S Holder · C-CSR1S Right Handle Ceramic-coated Stage with 1S Holder · C-CSR Right Handle Ceramic-coated Stage · NIU-CSRR2 Right Handle Rotatable Ceramic-coated Stage with 2S Holder Cross travel 78(X) x 54(Y) mm Handle height and torque adjustable
		<ul style="list-style-type: none"> · NI-S-E Motorized XY Stage Resolution: 0.1 µm · NI-SH-D Dish Holder (option) 		
Substages		<ul style="list-style-type: none"> · NI-SSR Substage (for Motorized Universal Condenser and Rotatable/Motorized stages) 	<ul style="list-style-type: none"> · NI-SSF Substage for Focusing Nosepiece (for LWD condenser and FN1 Standard/Motorized stages) 	<ul style="list-style-type: none"> · NI-SSR Substage (for Rotatable stage) · NI-SS Substage (for Non-rotatable stages)
Condensers (NA)	Motorized	<ul style="list-style-type: none"> · NI-CUD-E Motorized Universal Condenser Dry (0.88) For DIC, phase contrast, darkfield observations Attached on NI-SSR Substage 	—	—
	Manual	<ul style="list-style-type: none"> · NI-CUD Universal Condenser Dry (0.88) · C-C Abbe Condenser (0.9) · C-C Achromat Condenser (0.8) · Darkfield Condenser Oil (1.2-1.43) · Darkfield Condenser Dry (0.8-0.95) · C-C Achromat Aplanatic Condenser (1.4) · C-C Slide Achromat Condenser 2-100x (0.9) · C-C Achromat Swing-out Condenser 1-100x (0.8/0.12) · Achromat Swing-out Condenser 2-100x (0.9/0.22) · X LWD Condenser (0.65) · D-CUO DIC Condenser Oil (1.4) 	<ul style="list-style-type: none"> · FN-C LWD Condenser (0.78) (for DIC and oblique light illumination) 	<ul style="list-style-type: none"> · NI-CUD Universal Condenser Dry (0.88) · C-C Abbe Condenser (0.9) · C-C Achromat Condenser (0.8) · Darkfield Condenser Oil (1.2-1.43) · Darkfield Condenser Dry (0.8-0.95) · C-C Achromat Aplanatic Condenser (1.4) · C-C Slide Achromat Condenser 2-100x (0.9) · C-C Achromat Swing-out Condenser 1-100 (0.8/0.12) · C-C Phase Contrast Turret Condenser (0.9)^{*3} · Achromat Swing-out Condenser 2-100x (0.9/0.22) · X LWD Condenser (0.65) · D-CUO DIC Condenser Oil (1.4)
Epi-fluorescence illuminator	Filter cube turret	<ul style="list-style-type: none"> 6 filter cubes mountable, High S/N noise terminator mechanism for all turrets · NI-FLT6-E Motorized Epi-fluorescence Cube Turret Motorized shutter, Status check function^{*4} · NI-FLT6-I Intelligent Epi-fluorescence Cube Turret Manual shutter, Status check function^{*4} · NI-FLT6 Epi-fluorescence Cube Turret Manual shutter 		
	Light distribution device	<ul style="list-style-type: none"> · NI-FLEI Epi-fluorescence Attachment Aperture diaphragm and field diaphragm (Centerable/Detachable), ND filters (ND4, ND8, ND16) · NI-PAU Ni Photoactivation Unit (405 nm to 650 nm lasers) 		
	Option	<ul style="list-style-type: none"> · NI-BAW-E Motorized Barrier Filter Wheel 7 filters mountable, 0.2 sec between adjacent positions · NI-EXW-E Motorized Excitation Filter Wheel 8 filters mountable, 0.15 sec between adjacent positions · NI-SH-E Motorized Shutter 0.012 sec between open and close state 	<ul style="list-style-type: none"> · NI-SH-E Motorized Shutter 0.012 sec between open and close state 	
Epi-illumination light source		<ul style="list-style-type: none"> · C-LEDFl Epi-Fl LED Illuminator · C-HGFI/HGFIE HG Precentered Fiber Illuminator Intensilight (130W) · Hg Lamphouse and Power Supply (100W)^{*2} · Halogen Lamphouse and Transformer (100W)^{*2} 		
Power consumption		211W (with max. halogen lamp intensity and full motorized options)	96W (with max. halogen lamp intensity and full motorized options)	Main body: 133W (with max. halogen lamp intensity) Control Box B: 29W (with full motorized options)
Weight (approx.)		29 kg (Epi-fluorescent configuration with motorized quadocular tilting tube)	42 kg (Photoactivation configuration with motorized quadocular tilting tube)	20 kg (Brightfield configuration with ergonomic binocular tube)

*1 When used with a double layer, such as with layered epi-fluorescence cube turrets, F.O.V. is 22.

*2 Cannot be used with the focusing nosepiece type.

*3 Can only be mounted on the NI-SS Substage.

*4 Status check function: Status of Filter/Nosepiece etc. can be recorded with captured images and/or displayed on the controller monitor.

Company names and product names appearing in this brochure are their registered trademarks or trademarks.
N.B. Export of the products* in this brochure is controlled under the Japanese Foreign Exchange and Foreign Trade Law.
Appropriate export procedure shall be required in case of export from Japan.
*Products: Hardware and its technical information (including software)
Monitor images are simulated.



WARNING

TO ENSURE CORRECT USAGE, READ THE CORRESPONDING
MANUALS CAREFULLY BEFORE USING YOUR EQUIPMENT.

Specifications and equipment are subject to change without any notice or obligation on the part
of the manufacturer. July 2016 ©2011-16 NIKON CORPORATION



NIKON CORPORATION

Shinagawa Intercity Tower C, 2-15-3, Konan, Minato-ku, Tokyo 108-6290, Japan
phone: +81-3-6433-3705 fax: +81-3-6433-3785
<http://www.nikon.com/products/microscope-solutions/>

ISO 14001 Certified
for NIKON CORPORATION

NIKON INSTRUMENTS INC.

1300 Walt Whitman Road, Melville, N.Y. 11747-3064, U.S.A.
phone: +1-631-547-8500; +1-800-52-NIKON (within the U.S.A. only)
fax: +1-631-547-0306
<http://www.nikoninstruments.com/>

NIKON INSTRUMENTS EUROPE B.V.

Tripolis 100, Burgenweeshuispad 101, 1076 ER Amsterdam, The Netherlands
phone: +31-20-7099-000 fax: +31-20-7099-298
<http://www.nikoninstruments.eu/>

NIKON INSTRUMENTS (SHANGHAI) CO., LTD.

CHINA phone: +86-21-6841-2050 fax: +86-21-6841-2060
(Beijing branch) phone: +86-10-5831-2028 fax: +86-10-5831-2026
(Guangzhou branch) phone: +86-20-3882-0550 fax: +86-20-3882-0580

NIKON CANADA INC.

CANADA phone: +1-905-602-9676 fax: +1-905-602-9953

NIKON FRANCE S.A.S.

FRANCE phone: +33-1-4516-45-16 fax: +33-1-4516-45-55

NIKON GMBH

GERMANY phone: +49-211-941-42-20 fax: +49-211-941-43-22

NIKON INSTRUMENTS S.p.A.

ITALY phone: +39-55-300-96-01 fax: +39-55-30-09-93

NIKON GMBH SWITZERLAND

SWITZERLAND phone: +41-43-277-28-67 fax: +41-43-277-28-61

NIKON UK LTD.

UNITED KINGDOM phone: +44-208-247-1717 fax: +44-208-541-4584

NIKON CEE GMBH

AUSTRIA phone: +43-1-972-6111 fax: +43-1-972-611-140

NIKON SINGAPORE PTE LTD

SINGAPORE phone: +65-6559-3651 fax: +65-6559-3668

NIKON INSTRUMENTS KOREA CO., LTD.

KOREA phone: +82-2-2186-8400 fax: +82-2-555-4415

